



MOTOROLA
TALKABOUT®
TWO-WAY RADIO



6864110R40-C

Models T6200, T6210, and T6220

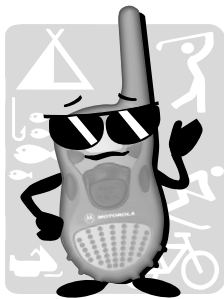

Introduction

Hi, I'm QuickStart and I'm going to help you get started!

The Motorola® Talkabout® T6200, T6210, and T6220 radios are durable two-way radios that operate on Family Radio Service (FRS) frequencies, require no service fee or license, and can be used anywhere in the United States and other areas as listed by the FCC.

These radios offer more than just a way of keeping in touch. The T6200 provides 14 channels and 38 interference eliminator codes, five audible call tones, accessory connector, signal-strength indicator, auto power off, and QuieT6000™.

The T6210 includes all the features found on the Motorola Talkabout T6200 plus features such as Eavesdrop Reducer and VibraCall® alert.

The T6220 includes five additional call tones, eight NOAA weather channels, and weather alert.

A detachable quick reference peel-off sticker that you can stick on the back of your radio is included. This sticker will help you identify the settings and icons displayed on your radio. This information is also included in the Getting Started section which begins on page 14.

Motorola, the Stylized M Logo, and all other trademarks indicated as such herein are trademarks of Motorola, Inc.

®Reg. U.S. Pat. & Tm. Off.

© 2000, 2001 Motorola, Inc. All rights reserved. Printed in the U.S.A.

Consumer Products Division
1125 Satellite Road, Suite 101
Suwanee, GA 30024-2880

***For a copy of a large-print version of this guide,
or for product-related questions, please call the
following numbers:***

1-800-353-2729 (U.S.A.)

1-800-461-4575 (Canada)

1-888-390-6456 TTY (Text Telephone)

1-888-390-6456 TTY (Text Telephone)

On the web, please refer to the Two-Way Radio section of

www.motorola.com/store

Contents

Introduction	1
Contents	3
Safety and General Information	5
<i>Charging Safety Instructions</i> ..	11
<i>Single-Unit Charger</i>	12
<i>Batteries</i>	12
Getting Started	14
Basic Operation of Your Radio ..	14
Installing Batteries	16
<i>Battery Meter</i>	18
<i>Battery Life</i>	18
<i>Charging the NiMH battery</i> ..	19
<i>Charging Status</i>	20
<i>Charging Dock</i>	21
Turning On Your Radio	23
<i>Your Radio's Display</i>	24
Turning Off Your Radio	24
Changing Settings While	
Turning On Your Radio	25
Accessing and Setting	
Features	26
Setting the Battery Type	26
Backlight	27

Talking and Listening	28
Before You Can Talk	28
<i>Setting the Channel</i>	28
<i>Setting the Interference</i>	
<i>Eliminator Code</i>	29
<i>Volume</i>	29
To Talk	30
<i>Talking Range</i>	30
<i>Using Accessories</i>	31
Monitor/Signal Strength	
Indicator	31
Alerts	32
Call Tone and Call Display	32
Ring Only (T6200 Only)	33
Ring and/or VibraCall®	
(T6210 and T6220 Only)	34
Talk Confirmation Tone	35
Button Beeps	35
Hands-Free Use (VOX)	36
Hands-Free Use	
With Accessories	36
<i>Setting Sensitivity Level</i>	37

Privacy	38	Other Important Features	44
Eavesdrop Reducer (T6210 and T6220 Only)	38	Lock	44
Quiet6000™	39	Scanning	44
<i>Unique Situations</i>	40	Auto Power Off	45
Weather (T6220 Only)	41	Reset	46
Turning On Weather		Simple Menu	46
Channel Reception	41	Use and Care	47
Setting the Weather		Frequency and Code Charts ...	48
Channel	42	Troubleshooting	50
Setting the Weather Alert	42	Motorola Limited Warranty	53

Safety and General Information

Important Information on Safe and Efficient Operation Read This Information Before Using Your Radio

The information provided in this document supersedes the general safety information contained in user guides published prior to July 2000. For information regarding radio use in a hazardous atmosphere please refer to the Factory Mutual (FM) Approval Manual Supplement or Instruction Card, which is included with radio models that offer this capability.

RF Operational Characteristics

Your radio contains a transmitter and a receiver. When it is ON, it receives and transmits radio frequency (RF) energy. The radio operates in the frequency range of 450 MHz to 470 MHz.

Exposure to Radio Frequency Energy

Your Motorola radio is designed to comply with the following national and international standards and guidelines regarding exposure of human beings to radio frequency electromagnetic energy:

- United States Federal Communications Commission, Code of Federal Regulations; 47 CFR part 2 sub-part J
- American National Standards Institute (ANSI) / Institute of Electrical and Electronic Engineers (IEEE) C95. 1-1992
- Institute of Electrical and Electronic Engineers (IEEE) C95.1-1999 Edition

- National Council on Radiation Protection and Measurements (NCRP) of the United States, Report 86, 1986
- International Commission on Non-Ionizing Radiation Protection (ICNIRP) 1998
- National Radiological Protection Board of the United Kingdom 1995
- Ministry of Health (Canada) Safety Code 6. Limits of Human Exposure to Radio Frequency Electromagnetic Fields in the Frequency Range from 3 kHz to 300 GHz, 1999

To assure optimal radio performance and make sure human exposure to radio frequency electromagnetic energy is within the guidelines set forth in the above standards, always adhere to the following procedures:

Portable Radio Operation and EME Exposure

Antenna Care

Use only the supplied or an approved replacement antenna. Unauthorized antennas, modifications, or attachments could damage the radio and may violate FCC regulations.

DO NOT hold the antenna when the radio is “IN USE”. Holding the antenna affects the effective range.

Two-Way Radio Operation



When using your radio as a traditional two-way radio, **hold the radio in a vertical position with the microphone two to three inches (5.0 to 7.5 cm) away from the lips.**

Body-Worn Operation

To maintain compliance with FCC RF exposure guidelines, if you wear a radio on your body when transmitting, always place the radio in **a Motorola supplied or approved clip, holder, holster, case, or body harness.** Use of non-Motorola-approved accessories may exceed FCC RF exposure guidelines. **If you do not use a body-worn accessory, ensure the antenna is at least one inch (2.5 cm) from your body when transmitting.**

Approved Accessories

For a list of approved Motorola accessories refer to the Two-Way Radio section of www.motorola.com/store.

Electromagnetic Interference/Compatibility

Note: Nearly every electronic device is susceptible to electromagnetic interference (EMI) if inadequately shielded, designed or otherwise configured for electromagnetic compatibility.

Facilities

To avoid electromagnetic interference and/or compatibility conflicts, turn off your radio in any facility where posted notices instruct you to do so. Hospitals or health care facilities may be using equipment that is sensitive to external RF energy.

Aircraft

When instructed to do so, turn off your radio when on board an aircraft. Any use of a radio must be in accordance with applicable regulations per airline crew instructions.

Medical Devices

Pacemakers

The Health Industry Manufacturers Association recommends that a minimum separation of 6 inches (15 centimeters) be maintained between a handheld wireless radio and a pacemaker. These recommendations are consistent with the independent research by, and recommendations of, Wireless Technology Research. Persons with pacemakers should:

- ALWAYS keep the radio more than six inches (15 centimeters) from their pacemaker when the radio is turned ON.
- not carry the radio in the breast pocket.
- use the ear opposite the pacemaker to minimize the potential for interference.
- turn the radio OFF immediately if you have any reason to suspect that interference is taking place.

Hearing Aids

Some wireless radios may interfere with some hearing aids. In the event of such interference, you may want to consult your hearing aid manufacturer to discuss alternatives.

Other Medical Devices

If you use any other personal medical device, consult the manufacturer of your device to determine if it is adequately shielded from RF energy. Your physician may be able to assist you in obtaining this information.

Safety and General Use While Driving

Check the laws and regulations on the use of radios in the area where you drive. Always obey them.

When using your radio while driving, please:

- Give full attention to driving and to the road.
- Use hands-free operation, if available.
- Pull off the road and park before making or answering a call if driving conditions so require.

Operational Warnings

For Vehicles with an Air Bag

Do not place a portable radio in the area over an air bag or in the air bag deployment area. Air bags inflate with great force. If a portable radio is placed in the air bag deployment area and the air bag inflates, the radio may be propelled with great force and cause serious injury to occupants of the vehicle.

Potentially Explosive Atmospheres

Turn off your radio prior to entering any area with a potentially explosive atmosphere, unless it is a radio type especially qualified for use in such areas as “Intrinsically Safe” (for example, Factory Mutual, CSA, or UL Approved). Do not remove, install, or charge batteries in such areas. Sparks in a potentially explosive atmosphere can cause an explosion or fire resulting in bodily injury or even death.

Note: The areas with potentially explosive atmospheres referred to above include fueling areas such as below decks on boats, fuel or chemical transfer or storage facilities, areas where the air contains chemicals or particles, such as grain, dust or metal powders, and any other area where you would normally be advised to turn off your vehicle engine. Areas with potentially explosive atmospheres are often but not always posted.

Blasting Caps and Areas

To avoid possible interference with blasting operations, turn off your radio when you are near electrical blasting caps, in a blasting area, or in areas posted: “Turn off two-way radio”. Obey all signs and instructions.

Operational Cautions

Antennas

Do not use any portable radio that has a damaged antenna. If a damaged antenna comes into contact with your skin, a minor burn can result.

Batteries

All batteries can cause property damage and/or bodily injury such as burns if a conductive material such as jewelry, keys, or beaded chains touch exposed terminals. The conductive material may complete an electrical circuit (short circuit) and become quite hot. Exercise care in handling any charged battery, particularly when placing it inside a pocket, purse, or other container with metal objects.

Charging Safety Instructions

Before using the battery charger, read all instructions and cautionary markings on the:

1. battery
2. battery charger, and
3. radio using the battery.

Caution: To reduce the risk of injury, charge only the rechargeable batteries listed. Other types of batteries may burst, causing personal injury and damage.

Single-Unit Charger

Kit Number	Description
NTN9393	110V - NiMH Charging Adapter

Batteries

Kit Number	Capacity in milliampere-hour mAh	Description	Composition
NTN9395	550 mAh	T6000-Series	NiMH

Save these Instructions

1. Do not expose the charger to rain or snow.
2. Do not operate the charger if it has received a sharp blow, or has been dropped or damaged in any way.
3. Do not disassemble the charger if it has received a sharp blow, or has been dropped or damaged in any way.
4. Never alter the AC cord or plug provided with the unit. If plug will not fit the outlet, have proper outlet installed by a qualified electrician. An improper condition can result in a risk of electric shock.
5. To reduce risk of damage to cord or plug, pull the plug rather than the cord when disconnecting charger from AC receptacle.
6. To reduce the risk of electric shock, unplug the charger from the outlet before attempting any maintenance or cleaning.

7. Use of an attachment not recommended or sold by Motorola may result in a risk of fire, electric shock, or personal injury.
8. Make sure that the cord is located so that it will not be stepped on, tripped over, or subjected to damage or stress.
9. An extension cord should not be used unless absolutely necessary. Use of an improper extension cord could result in a risk of fire and/or electric shock. If an extension cord must be used, make sure:
 - That the pins on the plug of the extension cord are the same number, size and shape as those on the plug of the charger.
 - That the extension cord is properly wired and in good electrical condition, and
 - That the cord size is 18 AWG for lengths up to 100 feet, and 16 AWG for lengths up to 150 feet.
10. The supply cord of this charger cannot be replaced. If the cord is damaged, call Motorola Product Services at:

1-800-353-2729 (U.S.A.)

1-800-461-4575 (Canada)

1-888-390-6456 TTY (Text Telephone)

1-888-390-6456 TTY (Text Telephone)





Getting Started

Basic Operation of Your Radio

Use  (Power) **to:**
- Turn power on/off

Use  **to:**
- Scroll through menus
- Lock the keypad (when held down and not in a menu)
- Exit the menu (when held down while in a menu)



Use  (Call) **to:**
- Transmit call tone

Use  **to:**
- Talk on the radio
- Exit the menu (when briefly pressed while in a menu)

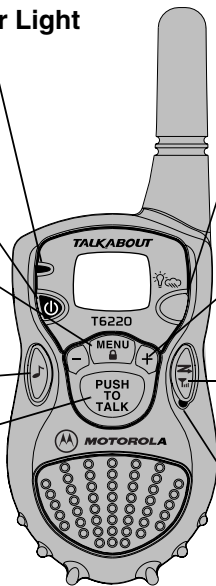
Indicator Light



Use  **to:**
- Turn on backlight (short press).
- Press and hold to switch between Weather Mode and Two-Way Mode (T6220 Only).

Use  **and**  **to:**
- Adjust volume
- Scroll through menu settings

Use  (Scan/Monitor) **to:**
- Turn Scan on/off (short press)
- Monitor the channel & check signal strength (long press)

Microphone



Belt Clip

- Squeeze the top and bottom of the clip to attach or detach the clip from the radio.

Note: The belt clip holds the radio while being worn on your belt. It was designed for your convenience and is not meant to secure your radio under all circumstances. For high activity environments, an accessory carry case is more appropriate to secure the radio.

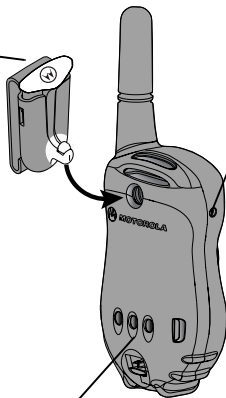

When using audio accessories, ensure that they are plugged in before you turn on the radio. *

* Motorola recommends that the volume level be kept at a comfortable listening level when using audio accessories.

NiMH Battery Charging Contacts

Check out the accessory brochure for other cool stuff available from Motorola.



Installing Batteries

Your radio uses three AA batteries or a rechargeable Nickel-Metal Hydride (NiMH) battery.

Some radio packages include a NiMH battery with charger adapter cover, charging dock, and charger. If you don't have these items, they're also available in the NiMH battery upgrade kit (56319). Call 1-800-353-2729 (U.S.A.) or 1-800-461-4575 (Canada) for the dealer nearest you.

- Turn off the radio by pressing and holding .
- Push latch up until it clicks.
- Lift back cover off.

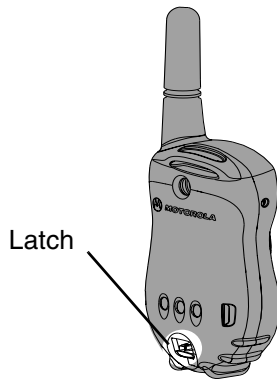

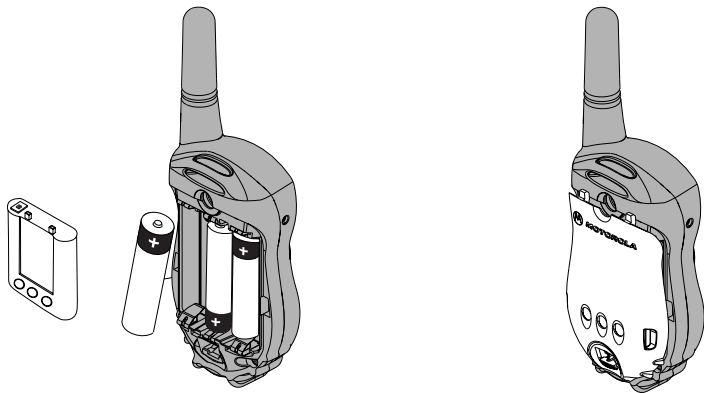





- Remove and replace batteries so the + marking matches the one in the compartment or the NiMH charge contacts are facing out toward the battery door.
- Hook back cover on the hinges.
- Close the battery door, pressing lightly until the latch clicks and returns to its original position.



Battery Meter



The battery meter on the top-left corner of the display shows how much battery power you have. It shows  (full),  (two-thirds full),  (one-third full), and  (empty). When it's , the radio beeps every 10 minutes. So, change or charge those batteries!

Battery Life

The following chart lists the approximate battery life during two-way use for alkaline and NiMH batteries. See page 26.

Battery Type	Two-Way Use*
AA alkaline	35 hours
NiMH	12 hours

*Two-way use is defined as 90% standby time, 5% talk time, and 5% receive time.

Note: Battery life will be reduced if you regularly use Hands-Free (VOX) accessories, Weather, or Scan.



Charging the NiMH Battery

Charge the NiMH battery overnight (16 hours) before using it for the first time, it will only need up to four hours of charging thereafter.

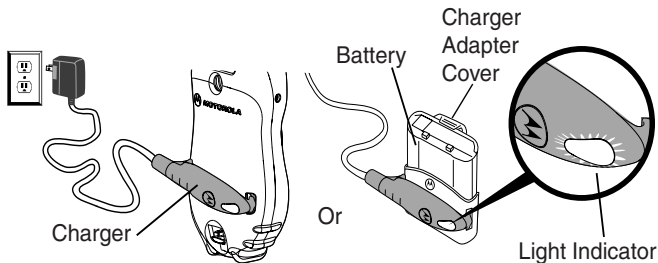

- Turn off the radio by pressing and holding , or place the NiMH battery in the charger adapter cover.

At the contacts on the back of the radio (or if you are charging just the battery, at the battery contacts):

- Position the charger so that the large hook on the end of the charger is over the large slot on the battery door or if you are charging the battery by itself, on the large slot on the charger adapter cover.
- Place the small hook on the other end of the charger over the small slot and snap it into place.
- Plug in the charger.



Charging Status

The Light Indicator shows the charging status when the charger is connected to the radio, the NiMH battery, or the charging dock.

Light Indicator Color	Charging Status and Description	Charging Level Complete
Solid Red	Rapid charging	Up to 90%
Flashing Green	Top-off charging	90% to 100%
Solid Green	Charging complete	100%
Flashing Red	Battery faulty If flashing red persists for more than one minute, the battery is faulty and should be replaced.	-
Flashing Yellow	Standby Battery waiting to charge. Temperature out of range for charging; must be between 5° to 40° C or 41° to 104° F	-

Note: When moving between hot and cold environments, do not charge the battery until the battery temperature acclimates (usually about 20 minutes).

Note: When charging the battery by itself, remove the charger from the charger adapter cover before inserting and/or removing the battery from the charger adapter cover.



Charging Dock

The charging dock provides drop-in charging convenience. The charging dock can be mounted or placed on any flat surface (such as a wall or workbench) and turns your radio into a stationary intercom while keeping it charged and ready for any adventure.

To mount the charging dock:

- Wrap the power cord under the charging dock. Use the cutouts to hold the cord in place.
- Attach using two #6 x $\frac{3}{4}$ " screws appropriate for the mounting surface.

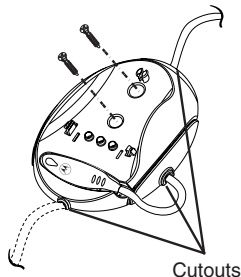



- Position the charger with the hook on the light indicator end over the left slot.
- Snap the hook on the cord end into the right slot, clamping the charger onto the charging dock contacts.
- Plug in the charger.

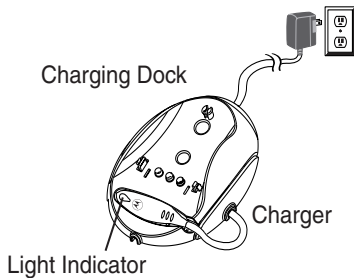

- Place the radio, or the NiMH battery in the charger adapter cover, into the charging dock until you hear a click.
- When the light indicator turns solid green, the battery is fully charged.

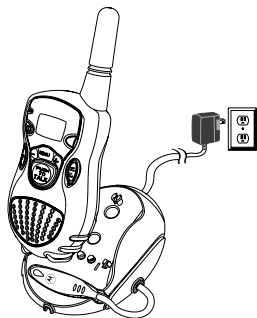





Turning On Your Radio

Press and Hold

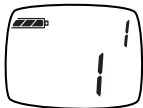
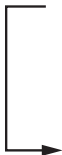
Normal Menu Mode



The radio beeps and the screen temporarily displays every image.

The red light above the  button flashes every three seconds.

Press and Hold

Simple Menu Mode (see page 46)

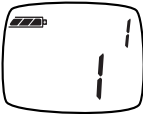
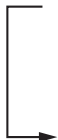

The radio beeps and the screen temporarily displays only six images.

The red light above the  button flashes every three seconds. You have access to only the Channel, Code, and Call Tone menus.



Your Radio's Display

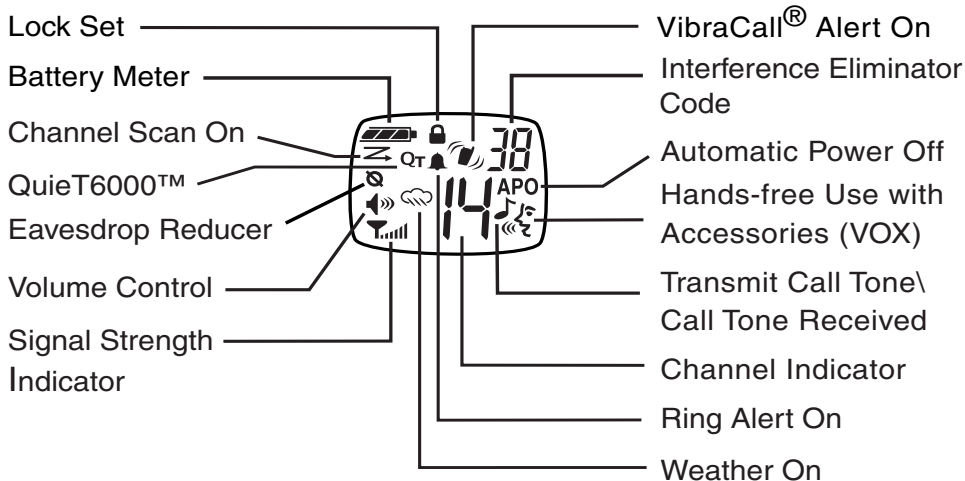















Turning Off Your Radio

To turn off your radio press and hold  for one second. The radio beeps and the display goes blank.





Changing Settings While Turning On Your Radio





The following table lists additional functions you can set by pressing and holding specific key combinations while turning on your radio.

Key(s) Pressed and Held While Turning On Your Radio	Function
 +  + 	Reset factory settings.
or  +  + 	
 + 	Turns audible button beeps and local audible call tones on or off.
 + 	Turns Talk Confirmation Tone on or off.
 + 	Turns on Simple Menu mode. See page 46.
 +  (Call)	Enable/disable Quiet6000 (Setting <i>l</i>) See page 39.
 + VOX accessory attached	Enable External VOX (with accessory).











Accessing and Setting Features

Almost everything you can do with your radio is done using the same basic key sequence! Use your radio's  and  or  to select options and set features the way you want them. All the features that work using this key sequence are described on the following pages.

Press	Display	Then Press
	the icon representing the feature you want	 or  to select the option, then press  or wait ten seconds (60 seconds for Simple Menu mode) to save the setting or press and hold  .

Setting the Battery Type

This feature allows the battery meter to recognize and properly display the power usage for either alkaline or rechargeable batteries.

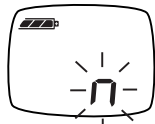

To set the battery type, press  until  displays. Either  (Alkaline) or  (NiMH or NiCad rechargeable) is blinking. Press  or  until your choice of  or  displays, then press  to set.





Backlight

Being in the dark is never a problem. Your radio has a backlight that turns on automatically any time you press a button. The backlight turns off automatically four seconds after you last pressed a button.

You can also illuminate your display by pressing the  button (T6200 and T6210) or   button (T6220).







Talking and Listening

Before You Can Talk

To talk with someone on your two-way radio, both of you must be on the same channel, interference eliminator code, and Eavesdrop Reducer code (T6210 and T6220 only).

The channel is the radio frequency wave your radio uses to transmit. The interference eliminator code filters out static, noise, and unwanted messages. Refer to the Frequency and Code Charts beginning on page 48 for channel and code choices. The Eavesdrop Reducer code makes your transmissions sound garbled to anyone listening who is not set to that code. See page 38.

Setting the Channel

To set the channel, press  once. The channel number begins to blink. Then press  or  to set the channel. Then proceed to the next menu or wait 10 seconds to save the channel setting. To quickly exit the menu and go back to the first display screen, press



The red indicator light above the  button flashes quickly whenever the channel is in use. Keep scrolling until you find a clear channel.



Setting the Interference Eliminator Code

To set the code, press **MENU** twice until the code number display begins to blink. Then press **-** or **+** to set the code. Press **PUSH TO TALK** to save the code setting. To hear everyone on your channel, select code **0**.



You can specify a different code for each channel. To set a channel and code combination, press **MENU** and then press **-** or **+** to select the channel. Press **MENU** again and then press **-** or **+** to select a code. Press **PUSH TO TALK** to exit the menu and to save the channel and code combination. To set another channel and code combination, repeat these steps.

Volume

*You can set the volume whenever you are not using a menu. Press **-** or **+** until it's just right. The display will show **◀▶▶** and the volume setting (1 to 5) with 1 being the lowest volume and 5 being the highest volume.*

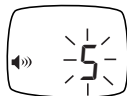



Caution: Do not hold the radio too close to your ear when the volume is at a high setting. This could cause hearing damage.



To Talk

Note: The microphone is located under the  button. So don't cover it when you press



Press and hold  and talk two-to-three inches away from the microphone. When you're finished, just release  (Press and hold to talk, release to listen). While transmitting, the red indicator light above the  button glows.

Talking Range

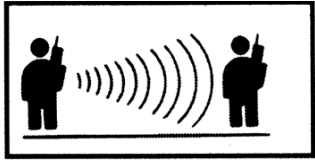

Optimal Range

- Flat, open areas from five feet up to two miles (line-of-sight)



Medium Range

- Buildings or trees

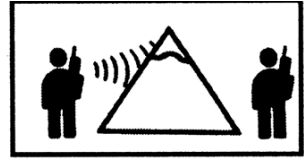

Minimal Range

- Dense foliage or mountains
- Buildings or vehicles



Using Accessories

Make sure the radio is turned off before plugging audio accessories into the accessory port. Before you place an accessory on your head or in your ear, turn the volume down. After placing the accessory on your head or in your ear, adjust the volume by pressing \ominus or \oplus .

Monitor/Signal Strength Indicator

The M button allows you to listen to all activity on a channel (open squelch) to tell whether the channel is currently in use. This button can also help you determine when a radio is moving out of range.

To check for channel activity, press and hold the M button. You'll hear static if the channel is clear and S will display. Don't transmit if you hear conversation. To avoid interrupted conversation, wait until the channel is clear or switch to another channel.

The S helps you determine when a radio is moving out of range by displaying a receive signal-strength value next to the S while you press and hold M . This value from 1 (weakest) through 5 (strongest) indicates the relative strength of the incoming signal.



Signal Strength Indicator

Note: Obstacles that block the signal path may affect the strength of the incoming signal.









Alerts

Alerts allow members of your group to notify each other that they want to talk. Alerts can be audible, visual, or vibrating.

You can also determine how your radio will alert you when you're receiving: vibrate, ring, both, or none. Your radio will vibrate and/or ring only the first time you receive a transmission or call. It will not ring or vibrate again until 30 seconds of inactivity have elapsed.

Call Tone and Call Display

Your radio can transmit different call tones to other radios in your group so you can alert them that you want to talk to them. Each person in the group can have an individual call tone.

To set your call tone, press  as needed to display . You can press  or  to scroll through the available call tones. The radio plays a sample of each tone as you scroll through them. To use your call tone, just press  to transmit it to others. The  displays next to the channel number.







Ring Only (T6200 Only)

The ring feature rings the call tone you've selected to notify you of two-way radio reception. When you set this feature, the radio produces the call tone you've selected each time you receive a two-way radio transmission.

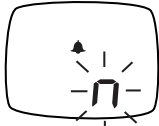
To set the Ring feature, press  until  is displayed and then press  or  to select  or .







If you select , the  will remain on the display after you exit the menu.



Ring and/or VibraCall® (T6210 and T6220 Only)

Your radio features Ring and/or VibraCall®, a vibrating alert to notify you of two-way radio reception in noisy environments.

To set Ring and/or VibraCall®, press  until  and/or  is displayed and then press  or  to select the desired setting.

Setting	Display Within Menu	Function
-		Your radio doesn't sound an alert, just the actual transmission. You will still hear the talk confirmation tone (if activated).
1		Your radio vibrates to alert you.
2		Your radio rings your call tone when you receive a call.
3		Your radio vibrates and rings your call tone when receiving.



Talk Confirmation Tone

Whenever you turn on the talk confirmation tone feature, your two-way radio transmits a unique tone when you finish transmitting. It's like saying "Roger" or "Over" and lets others know you're finished talking. If you don't hear the talk confirmation tone, you can enable it by pressing and holding (+) as you turn on your radio. Now, whenever you release the (PUSH TO TALK) button, you let your friends know you're finished talking by transmitting a tone. To disable the talk confirmation tone feature, turn your radio off and then back on while pressing and holding (+).

Button Beeps

Every time you press a button on your radio, it beeps unless you turn Button Beeps off. To turn button beeps off, turn your radio on while you press and hold (-). To turn button beeps back on, turn the radio off and then back on again while you press and hold (-).

When Button Beeps are turned off, you won't hear call tones that you send.





Hands-Free Use (VOX)

Hands-Free Use With Accessories

VOX allows you to transmit “hands-free” by talking while using VOX accessories connected to the radio.

To set VOX, plug in your accessory before you turn on your radio. When you turn on your radio, flashing « displays. Your radio will now detect your voice and transmit every time you talk. When you transmit using a VOX headset, you will hear yourself talking through the accessory speaker. This lets you know VOX is working.

Press  to turn off VOX and return to the regular way of transmitting. The « will disappear. To reset VOX use, turn your radio off and then back on with your accessory plugged in.

Note: When using accessories, ensure that they are plugged in before you turn on the radio.

Note: There is a short delay when you start talking before the transmitter turns on.



Setting Sensitivity Level

The sensitivity level allows you to compensate for background noise when using an accessory. If you are not using an accessory, the sensitivity level will adjust your microphone's sensitivity. By adjusting the sensitivity level up or down, you can minimize the chance of unintended noises triggering a transmission, or increase the microphone's ability to pick up quiet voices.

To set sensitivity level, press **MENU** as needed, until  and a value 1 through 3 are displayed. Then select:

High (3) for quiet environments

Medium (2) for most environments

Low (1) for noisy environments

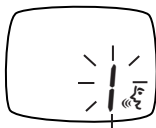

When you connect a VOX accessory, the radio will automatically be set to your last sensitivity level.





Privacy

Eavesdrop Reducer (T6210 and T6220 Only)





Your radio has the Eavesdrop Reducer feature, a scramble code that makes your transmissions sound garbled to anyone listening without the same code. It doesn't guarantee secrecy, but it adds an extra layer of privacy.

Don't forget -- all the radios have to be set to the same Eavesdrop Reducer code for the transmissions to be clear.

To turn the Eavesdrop Reducer feature on, press  as needed until  is displayed, then select code 1, 2, or 3.



After you exit the menu, the display will show .

To turn the Eavesdrop Reducer feature off, press  as needed until  is displayed, then select -. After you exit the menu, the  icon will disappear from the display.

Quiet6000™

The Quiet6000™ function helps ensure uninterrupted communication among Motorola Talkabout T6200 and T6300 series radios - it helps prevent you from hearing transmissions from other radios. However, other radios can hear you.

To turn the Quiet6000 function on or off, press  as needed until **QT** is displayed. Then select one of the following settings:



Setting	Display	Function
-		Quiet6000 is turned off.
1		Quiet6000 is turned on, but is suspended while scanning.
2		Quiet6000 is turned on, including while scanning.

You can also turn the Quiet6000 function on (Setting 1) or off (Setting -) by pressing and holding  while you turn on your radio.









Quiet6000™ (Continued)

If you have a T6200 radio with Quiet6000 on and want to talk to others in your group who also have Quiet6000 on, you must first transmit a call tone before talking to them. When the call tone is transmitted,  will display on the other T6200 or T6300 series radios with the same channel, interference eliminator code, and Quiet6000 on, letting them know that you want to talk to them. Those radios can then receive and transmit until 30 seconds of inactivity occurs, which resets the Quiet6000 function. While Quiet6000 is on,  is displayed to indicate that the function is on. However, during the 30 seconds of inactivity,  will flash.

Unique Situations

Quiet6000 can also keep your radio quiet when you are in a situation where noise can be disruptive, such as when you are in a movie theater or out hunting. Set Quiet6000 to either  or  and set your radio's alert to  (VibraCall only). Now when you receive a call from another T6200 or T6300 series radio, your radio will vibrate while the  displays on the screen. The  will remain on the screen until you press any button. Only then can you receive and transmit to those radios until 30 seconds of inactivity occurs and the Quiet6000 function resets.

Weather (T6220 Only)







You can't change the weather, but you can be prepared for it whenever you take your Motorola Talkabout T6220 radio with you. That's because it tunes into National Oceanic and Atmospheric Administration (NOAA) Weather Radio broadcasts. You can listen to a weather channel or you can even set your radio to alert you to emergency weather broadcasts.

And because NOAA Weather Radio now broadcasts warning information for all types of hazards, routine broadcasts are interrupted during emergencies for natural and technological warnings, watches, and other critical information.

NOAA has transmitters located throughout the United States and Canada that broadcast National Weather Service warnings, watches, forecasts, and other hazard information 24 hours a day.

Whenever you listen to a weather channel, you cannot use your radio for two-way communications. However, a weather alert will notify you while the radio is in two-way mode (if you have enabled weather alert) and the radio is on but not transmitting or receiving.

Turning On Weather Channel Reception

To turn on weather channel reception, press and hold the   button. To turn off weather channel reception and return to two-way mode, press and hold the   button again.







Setting the Weather Channel

Your radio receives eight NOAA frequencies. See the Frequency and Code Charts beginning on page 48 for a complete list.

After turning on the weather broadcast, press  to start the channel display blinking.

Press  or  to select the strongest channel.







As with two-way radio reception, weather channel reception depends on how close you are to a transmitter and whether you are indoors or outdoors. Also, because weather channels are transmitted without codes, they may contain static or noise.

Note: In some isolated areas, it may not be possible to receive weather channel transmissions.

Setting the Weather Alert

If you set the weather alert and switch back to two-way mode, ☁ is displayed. Whenever NOAA transmits an emergency weather broadcast on the selected channel, your radio alerts you using the selected alert mode, ring 📞 or vibrate 📵, and switches to the selected weather channel. If your radio is in weather mode, you will receive a weather alert only on the selected channel.

To set weather alerts, switch to weather mode, press  twice, and press  or  to select  (on).



Note: The TalkAbout T6200-series two-way radios are designed to be two-way radios primarily, with the added utility of features such as Weather Alert. The radio uses the same circuitry for both two-way radio and weather alert receptions. Therefore, you can miss a weather alert while you are engaged in two-way communication (either transmitting or receiving). To ensure that you do not miss a weather alert, leave the radio in the Weather Mode.



Other Important Features

Lock

To avoid accidentally changing radio operation, the Lock feature locks the Menu, Volume Control, Weather (T6220 only), and Scan functions. Meaning that you can only turn the two-way radio on and off, transmit, and monitor

You can make sure your menu settings won't be changed accidentally. Just turn on lock by pressing  for three seconds.

Now you'll see the  icon.

To turn Lock off, press  again for three seconds.

Lock On









Note: If your radio is in two-way mode and Weather Alert is enabled, an emergency broadcast on the selected channel will still switch the radio to that weather channel.

Scanning

By using Scanning , you can monitor channels and codes for transmissions and lock in on the one that interests you. More importantly, you can find someone in your group who has accidentally changed channels and is talking during your scan. You don't have to set a new channel or code, the radio just resets itself temporarily to that channel and code and you can start talking.





Scanning (Continued)

To start scanning, briefly press  (Scan/Monitor). Your channel/code screen displays  and begins to scroll through channels. When the radio detects channel activity, it stops on that channel and displays its channel and code. You can talk to the person(s) transmitting without having to switch channels by pressing . To stop scanning, briefly press . If you press  while the radio is scanning, the radio will transmit on the channel you selected before you activated Scan. If no transmission occurs within five seconds, scanning will resume.

If you want to scan channels without interference eliminator codes, change the code for your set channel to  before you briefly press .

Auto Power Off

You can program your radio to turn itself off after a certain period of inactivity. This helps save battery life.





To set the automatic power off feature, press  as needed to display **APO**. Press  or  to set the number of hours  - , after which power shuts off.



After you exit the menu, **APO** displays on the screen when the automatic power off feature has been activated. Five minutes before the radio shuts off, an alert beep sounds. Another alert beep will sound once per minute and **APO** will flash continuously during those five minutes.



Select  to turn off the automatic power off feature.





Reset

You can reset your radio's menu settings to the factory settings by turning it on while pressing and holding  and  or  and .

Simple Menu

Simple Menu allows you to limit the number of menus displayed (Channel, Code, and Call Tones) to allow for simpler radio operation. The Scan and Weather features, along with most of the radio turn-on sequences (See page 25), are also disabled to prevent accidentally changing the radio's mode of operation.

If you want the radios in your group to keep the same settings that you have on your radio, press  as you turn each radio on. Simple Menu increases the menu time-out to 60 seconds. To turn off Simple Menu, press  as you turn on the radio.

If you want to set up Simple Menu for inexperienced users, without advanced features activated such as Eavesdrop Reducer and Quiet6000, reset their radios to the original factory settings by either pressing  and  or by pressing  and  while turning on their radios. Then activate Simple Menu by turning their radios off and then back on while pressing .

Use and Care



Use a soft damp cloth to clean the exterior.



Do not immerse in water.



Do not use alcohol or cleaning solutions.

If the radio gets wet...



Turn it off and remove batteries.



Dry with soft cloth.



Do not use until completely dry.



Frequency and Code Charts

The charts on these pages provide frequency and code compatibility information. These charts are useful when using Motorola Talkabout two-way radios with other FRS radios.

Channel Frequency Chart

Channel	MHz	Channel	MHz
1	462.5625	8	467.5625
2	462.5875	9	467.5875
3	462.6125	10	467.6125
4	462.6375	11	467.6375
5	462.6625	12	467.6625
6	462.6875	13	467.6875
7	462.7125	14	467.7125

Weather Frequency Chart (T6220 Only)

WX1	162.550	WX5	162.450
WX2	162.400	WX6	162.500
WX3	162.475	WX7	162.525
WX4	162.425	WX8	162.275

Carrier squelch (0) disables interference eliminator codes. This allows you to monitor all activity on the channel you are using.



Interference Eliminator Codes

Talkabout Code	Hz Freq	Motorola 7/7x Code	Talkabout Code	Hz Freq	Motorola 7/7x Code	Talkabout Code	Hz Freq	Motorola 7/7x Code
1	67.0		14	107.2	D	27	167.9	
2	71.9		15	110.9		28	173.8	
3	74.4		16	114.8		29	179.9	
4	77.0	A	17	118.8	E	30	186.2	
5	79.7		18	123.0		31	192.8	
6	82.5		19	127.3	F	32	203.5	
7	85.4		20	131.8		33	210.7	
8	88.5	B	21	136.5	G	34	218.1	
9	91.5		22	141.3		35	225.7	
10	94.8		23	146.2		36	233.6	
11	97.4	C	24	151.4		37	241.8	
12	100.0		25	156.7		38	250.3	
13	103.5		26	162.2				

Note: Motorola 7/7x is an older Motorola radio that has seven codes common with newer FRS radios.



Troubleshooting

Symptom

Try This:

No Power

Reposition or replace alkaline batteries.

Recharge or replace NiMH battery.

Message not transmitted

Make sure  is completely pressed as you transmit.

Reposition, replace, or recharge batteries.

Hearing other noises or conversation on a channel

Confirm interference eliminator code is set.

Shared channel or interference eliminator code may be in use, try another.

Message scrambled



Eavesdrop Reducer code is on, or setting does not match other radios' settings; all radios must use the same Eavesdrop Reducer code.

Limited talk range



Steel and/or concrete structures, heavy foliage, use in buildings or vehicles decrease range. Check for clear line of sight to improve transmission.

Wearing radio close to body such as in a pocket or on a belt decreases range. Change location of radio.



Symptom	Try This:
Message not received	<p>Confirm radios have the same channel and interference eliminator code settings.</p> <p>Make sure  is NOT being pressed while trying to listen.</p> <p>Reposition, replace, or recharge batteries.</p> <p>If QuietT6000 feature is on, transmit call tone before talking.</p> <p>If QuietT6000 feature is on, with only VibraCall selected, a received call must be acknowledged by pressing any button (or a VOX activation) before the radio can receive any incoming transmissions.</p> <p>Obstructions and operating indoors, or in vehicles, may interfere -- change location.</p> <p>Verify that the radio is not in Scan mode.</p> <p>Eavesdrop Reducer code is on, or setting does not match other radios; all radios must use the same Eavesdrop Reducer code.</p>
Heavy static or interference	<p>Radios are too close, they must be at least five feet apart.</p> <p>Radios are too far apart or obstacles interfering with transmission. Talk range is up to two miles in clear, unobstructed conditions.</p>
Channel and/or code locked	<p>Make sure menu is unlocked. Unlock by pressing  for three seconds.</p>



Symptom	Try This:
Cannot access all menus or Cannot display desired icon	Verify whether Simple Menu is activated. Disable Simple Menu by pressing  while turning on the radio.
Other radios not receiving your transmissions	Quiet6000 mode is set. Press  to talk to members of your party or turn Quiet6000 off.
Low batteries	Replace alkaline batteries. Recharge or replace NiMH battery. Extreme operating temperatures affect battery life.
Low battery meter reading although new batteries are installed	Verify that the radio is set to the correct battery type. See page 26.
Charger LED double flashing	Charger not properly positioned. Reposition charger and ensure it is firmly clamped to the radio, battery, or charging dock. Battery power is very low; battery is charging up slowly before it starts to quick charge.
Cannot activate VOX	Feature not set and on. See page 36.

Motorola Limited Warranty

Motorola Personal Communications Products Purchased in the United States and Canada

I. What This Warranty Covers

- Products. Defects in materials and workmanship in wireless cellular telephones, pagers, and/or two-way radios, and certain accessories that are sold with them, such as the battery, battery charger and holster manufactured and/or sold by Motorola (Products).
- Batteries. Defects in materials and workmanship in batteries that are manufactured by Motorola and/or sold with Products are covered by this warranty only if the fully-charged capacity falls below 80% of rated capacity or they leak.
- Software. Physical defects in the media that tangibly embodies each copy of any software supplied with the Products.

II. What the Period of Coverage Is

From the date the Products are purchased by the first end-user:

- Products. The warranty is for one year. Exception: The warranty for Spirit GT series and Talkabout series two-way radio accessories is for 90 days.
- Software. The warranty is for 90 days.
- Repairs / Replacements. The warranty is for the balance of the original warranty or for 90 days from the date you receive it, whichever is longer.

III. Who is Covered

This warranty extends to the first end-user purchaser, only.

IV. What We Will Do to Correct Warranty Problems

At no charge to you, we have the option to repair or replace the Products or software that do not conform to the warranty, or to refund the Products' purchase price. We may use functionally equivalent reconditioned/refurbished/pre-owned or new Products or parts. No software updates are provided.

V. How to Get Warranty Service

Please call:

USA

1-800-353-2729

1-888-390-6456 TTY (Text Telephone)

Canada

1-800-461-4575

1-888-390-6456 TTY (Text Telephone)

You will receive instructions on how to ship the Products to Motorola. You must ship the Products to us with freight, duties and insurance prepaid. Along with the Products you must include: (a) a copy of your receipt, bill of sale or other comparable proof of purchase; (b) a written description of the problem; (c) the name of your service provider (if this Product requires subscription service); (d) the name and location of the installation facility (if applicable) and, most importantly; (e) your address and telephone number. If requested, you must also return all detachable parts such as antennas, batteries and chargers. **RETAIN YOUR ORIGINAL PROOF OF PURCHASE.**

We will ship repaired or replacement Products at our expense for the freight and insurance, but at your expense for any duties. If additional information is needed, please contact us at the telephone number listed above.

VI. What This Warranty Does Not Cover

- Products that are operated in combination with ancillary or peripheral equipment or software not furnished by Motorola for use with the Products (“ancillary equipment”), or any damage to the Products or ancillary equipment as a result of such use. Among other things, “ancillary equipment” includes batteries, chargers, adaptors, and power supplies not manufactured or supplied by Motorola. Any of these voids the warranty.
- Someone other than Motorola (or its authorized service centers) tests, adjusts, installs, maintains, alters, modifies or services the Products in any way. Any of these voids the warranty.
- Rechargeable batteries that: (a) are charged by other than the Motorola-approved battery charger specified for charging such batteries; (b) have any broken seals or show evidence of tampering; (c) are used in equipment other than the Product for which they are specified; or (d) are charged and stored at temperatures greater than 60 degrees centigrade. Any of these voids the warranty.
- Products that have: (a) serial numbers or date tags that have been removed, altered or obliterated; (b) board serial numbers that do not match each other, or board serial numbers that do not match the housing; or (c) nonconforming or non-Motorola housings or parts. Any of these voids the warranty.
- Defects or damage that result from: (a) use of the Products in a manner that is not normal or customary; (b) improper operation or misuse; (c) accident or

neglect such as dropping the Products onto hard surfaces; (d) contact with water, rain, extreme humidity or heavy perspiration; (e) contact with sand, dirt or the like; or (f) contact with extreme heat, or spills of food or liquid.

- Physical damage to the surface of the Products, including scratches, cracks or other damage to a display screen, lens or other externally exposed parts.
- Failure of Products that is due primarily to any communication service or signal you may subscribe to or use with the Products.
- Coil cords that are stretched or that have any broken modular tabs.
- Products that are leased.

Flat-rate repair rates may apply to Products not covered by this warranty. To obtain information about Products needing repairs that are not covered by this warranty, please call the telephone number previously listed. We will provide information on repair availability, rates, methods of payment, where to send the Products, etc.

VII. Some Other Limitations

This is Motorola's complete warranty for the Products, and states your exclusive remedies. This warranty is given in lieu of all other express warranties. Implied warranties, including without limitation, the implied warranties of merchantability and fitness for a particular purpose, are given only if specifically required by applicable law. Otherwise, they are specifically excluded.

No warranty is made as to coverage, availability, or grade of service provided by the Products, whether through a service provider or otherwise.

No warranty is made that the software will meet your requirements or will work in combination with any hardware or applications software products provided by third parties, that the operation of the software products will be uninterrupted or error free, or that all defects in the software products will be corrected.

In no event shall Motorola be liable, whether in contract or tort (including negligence) for damages in excess of the purchase price of the Product, or for any indirect, incidental, special or consequential damages of any kind, or loss of revenue or profits, loss of business, loss of information or data, or other financial loss arising out of or in connection with the ability or inability to use the Products, to the full extent these damages may be disclaimed by law.

VIII. Patent and Software Provisions

At Motorola's expense, we will defend you, and pay costs and damages that may be finally awarded against you, to the extent that a lawsuit is based on a claim that the Products directly infringe a United States patent. Our obligation is conditioned on: (a) you notifying us promptly in writing when you receive notice of the claim; (b) you giving us sole control of the defense of the suit and all negotiations for its settlement or compromise; and (c) should the Products become, or in Motorola's opinion be likely to become, the subject of a claim of infringement of a United States patent, you permit us, at our option and expense, either to: procure for you the right to continue using the Products; replace or modify them so that they become non-infringing; or grant you a credit for such Products, as depreciated, and accept their return. The depreciation will be an equal amount per year over the lifetime of the Products, as established by Motorola.

Motorola will have no liability to you with respect to any claim of patent infringement that is based upon the combination of the Products or parts furnished under this limited warranty with ancillary equipment, as defined in VI., above.

This is Motorola's entire liability with respect to infringement of patents by the Products.

Laws in the United States and other countries preserve for Motorola and other third party software providers certain exclusive rights for copyrighted software, such as the exclusive rights to reproduce in copies and distribute copies of

such software. The software may be copied into, used in and redistributed with only those Products that are associated with such software. No other use, including without limitation, disassembly or reverse engineering of such software or exercise of exclusive rights in such software is permitted.

IX. State Law and Other Jurisdiction Rights

Some states and other jurisdictions do not allow the exclusion or limitation of incidental or consequential damages, or limitation on the length of an implied warranty, so the above limitations or exclusions may not apply to you.

This warranty gives you specific legal rights, and you may also have other rights, which vary from jurisdiction to jurisdiction.

To obtain information on Motorola Personal Communications Products, including warranty service, accessories and optional Extended Warranties on selected Products, please call:

USA

1-800-353-2729

1-888-390-6456 TTY (Text Telephone)

Canada

1-800-461-4575

1-888-390-6456 TTY (Text Telephone)

To correspond with Motorola about the Products, please write us at

<http://www.motorola.com> or at:

USA

Motorola, Inc.
600 North U.S. Highway 45
Libertyville, IL 60048

Canada

Motorola Canada Limited
5875 Whittle Road
Mississauga, ON L4Z 2H4

Computer Software Copyrights

The Motorola equipment described in this manual may include copyrighted Motorola computer programs stored in semiconductor memories or other media. Laws in the United States and other countries preserve for Motorola certain exclusive rights for copyrighted computer programs, including the exclusive right to copy or reproduce in any form the copyrighted computer program. Accordingly, any copyrighted Motorola computer programs contained in the Motorola equipment described in this manual may not be copied or reproduced in any manner without the express permission of Motorola, Inc. Furthermore, the purchase of Motorola equipment shall not be deemed to grant either directly or by implication, estoppel, or otherwise any license under the copyrights, patents or patent applications of Motorola, except for the normal nonexclusive, royalty free license to use arising by operation of law in the sale of this product.

Patent Notice

This product is covered by one or more of the following United States patents.

5896277	5894292	5864752	5699006	5742484	D408396	D399821	D387758
D389158	5894592	5893027	5789098	5734975	5861850	D395882	D383745
D389827	D389139	5929825	5926514	5953640	6071640	D413022	D416252
D416893	D433001						

FCC License Not Required

Changes or modifications not expressly approved by Motorola may void the user's authority granted by the FCC to operate this radio and should not be made. To comply with FCC requirements, transmitter adjustments should be made only by or under the supervision of a person certified as technically qualified to perform transmitter maintenance and repairs in the private land mobile and fixed services as certified by an organization representative of the user of those services. Replacement of any transmitter component (crystal, semiconductor, etc.) not authorized by the FCC equipment authorization for this radio could violate FCC rules.

Note: Use of this radio outside the country where it was intended to be distributed is subject to government regulations and may be prohibited.

Export Law Assurances

This product is controlled under the export regulations of the United States of America and Canada. The governments of the United States and Canada may restrict exportation and re-exportation of this product to certain destinations. For further information, contact the U.S. Department of Commerce or the Canadian Department of Foreign Affairs and International Trade.

- **No license fee or airtime charges!**

- **Up to 2 mile range**

*Depending on terrain and conditions

- **Quiet6000™**

Helps keep radios outside your group from disturbing you with ring tones or conversation

- **Automatic Power Off**

Saves battery life by shutting down after user-defined period of inactivity

- **Keypad Lock**

Prevents your settings from being accidentally changed

- **Low Battery Alert**

Audible tone and visual display tell you your battery is running down

- **Weather-resistant**

- **14 channels, each with 38 interference eliminator codes**

Privacy feature that helps minimize interference from other groups

- **“Roger” Beep**

Signals others you’re done talking

- **Call Button**

Get others’ attention before you start talking

- **Scan**

Easily finds your group’s channel and code by searching all combinations

- **Durable, fixed antenna**

Maximizes talk range

- **1 Year Limited Warranty**

For warranty details call 1-800-353-2729

- **User’s guide included**

- **Quick release Swivel Belt Clip included**

- **Illuminated display**

Easy to read your settings in dark places

- **Talk Hands-Free (VOX)**

“Voice activation” (VOX) lets you talk hands-free when used with optional accessories

- **Multiple Audible Call Tones**

Multiple distinct ringing options so your group can identify who’s calling

- **Button Beeps (on/off)**

Silences the beeps to avoid disturbing others

- **Batteries (not included)**

Requires 3 AA Alkaline batteries or one NiMH rechargeable battery

• **Accessories for T6200 series - Convenient headphones, some with hands-free talk capabilities, mesh and waterproof carry cases, and rechargeable battery packs available from your retailer or www.motorola.com**

MOTOROLA, the Stylized M Logo, TALKABOUT, and all other trademarks indicated as such herein are trademarks of Motorola, Inc. © Reg. U.S. Pat. & Tm. Off. All other product or service names are the property of their respective owners. © 2001 Motorola, Inc. All rights reserved. Printed in the U.S.A.



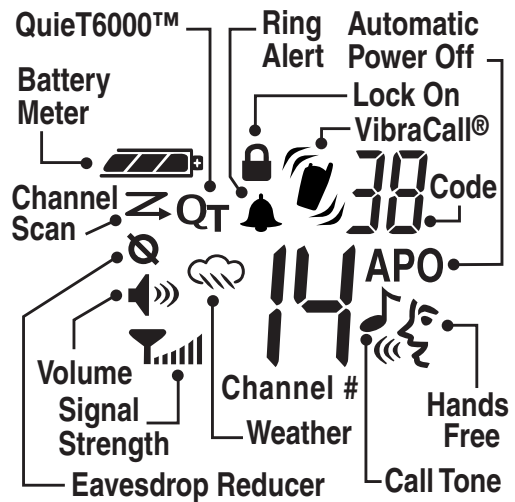









 **WARNING**
CHOKING HAZARD - SMALL PARTS
Not for children under 3 years.
This product is not intended to be used as a toy or plaything.



***T6200-Series
Two-Way Radio
Quick Reference***



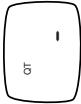

Detailed steps contained in the User's Guide.

T6200-Series Two-Way Radio Menu Map

Press  Press  or 	
Channel 	1 through 14
Interference Eliminator Code 	0 through 3B
Eavesdrop Reducer (T6210 & T6220) 	- (off) 1, 2, 3
Call Tone/Call Display 	1 through 5 (T6200 & T6210) 1 through 1B (T6220 Only)
Ringer (T6200 Only) 	0 (off) 1 (on)
Ringer VibraCall (T6210 & T6220) 	- (neither) 1 (vib) 2 (ring) 3 (vib + ring)
Sensitivity Levels 	1 low (in noisy places) 2 medium (most places) 3 high (in quiet places)
Automatic Power Off 	- (off) 1 to B hours
QuietT6000™ 	- (off) 1 (on) except during scan 2 (on) including during scan
Battery Type 	A (alkaline) 0 (NiMh)

To switch between Two-Way mode and Weather mode (T6220 only) press and hold .

T6220 Radio Weather Feature Map

Press  Press  or 	
Weather Channel 	1 through B
Weather Alert 	0 (off) 1 (on)